

# INSTRUCCIONES DE MONTAJE

## ARTÍCULO 508111D

### MODELO DIMABLE

**ATENCIÓN:** Schuller recomienda que utilice los balancines suministrados en la instalación de este colgante.

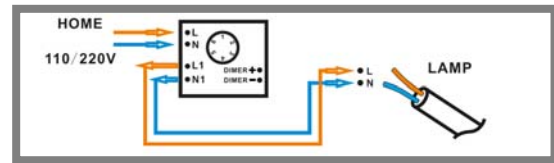
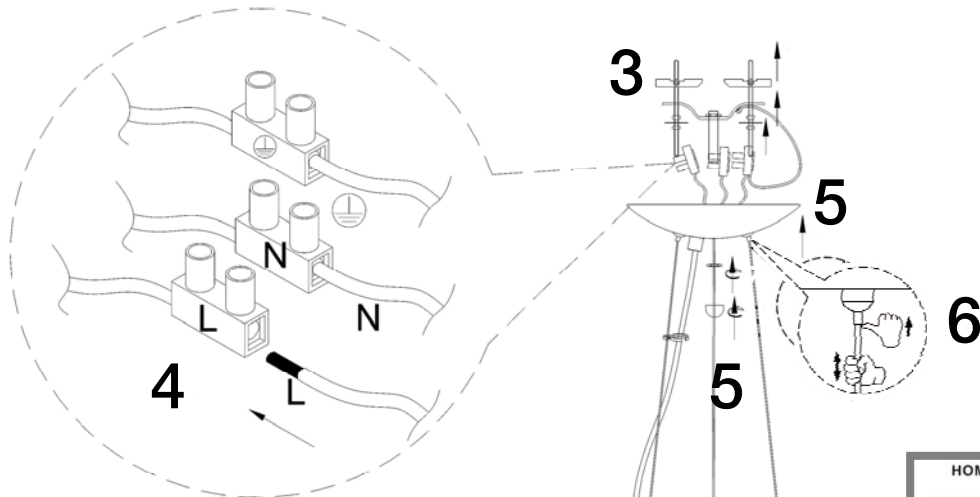

#### ATENCIÓN

Este producto incluye bombillas led dimables, un receptor y un mando a distancia por radiofrecuencia. Para utilizar con regulador de pared, éste debe ser adecuado para led. El receptor instalado en el producto tiene seleccionado el canal número 1, use este mismo canal en el mando a distancia.

LA FABRICACIÓN  
ARTESANAL DE ESTA TULIPA  
DE CRISTAL PERMITE  
LIGERAS IMPERFECCIONES  
ACEPTADAS POR NUESTRO  
CONTROL DE CALIDAD.

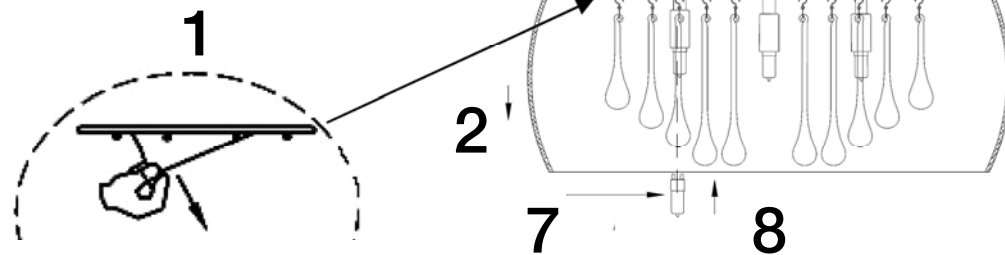

Retire el papel adhesivo protector  
antes de poner las bombillas

NOTA: Incluye los  
siguientes repuestos:  
1pcs 1pcs 1pcs 1pcs



16cm 14cm 12cm 10cm

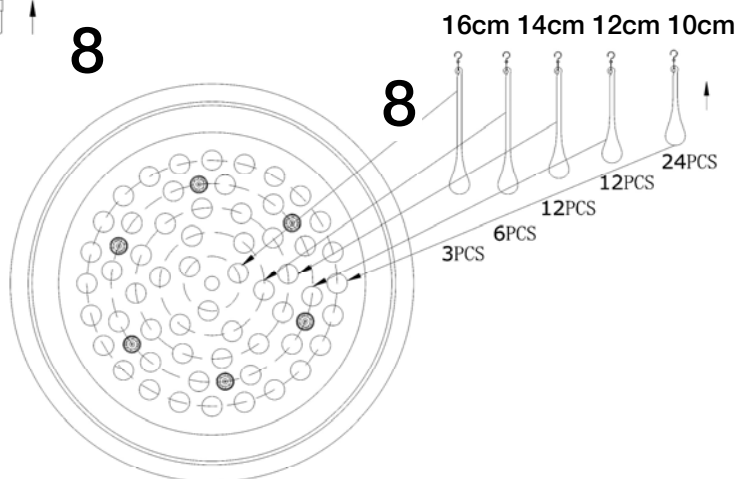

NOTA: Para evitar riesgos, si el cable eléctrico de este artículo sufre algún daño, deberá ser reparado por personal cualificado. Para ver la ficha técnica de producto completa, puede usar el siguiente código QR:



# ASSEMBLING INSTRUCTIONS

## ITEM 508111D

### DIMMABLE ITEM

**IMPORTANT NOTICE:** Schuller recommends to use those included special screws when installing this pendant lamp.

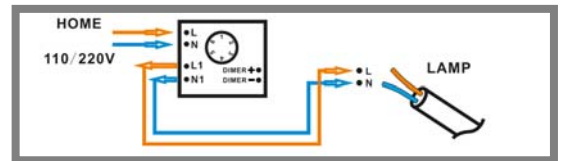
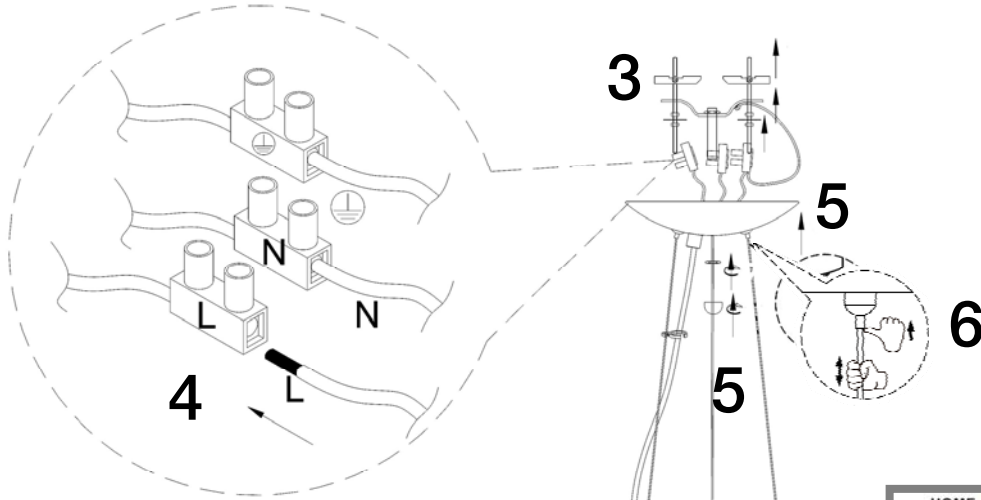

CRAFTMAN PRODUCTION FOR THIS GLASS SHADE ALLOWS SMALL IMPERFECTIONS CHECKED BY OUR QUALITY CONTROL

**WARNING**  
 This product includes dimmable led light bulbs, a receiver and radio frequency remote control. If to be used with wall control, this wall control must be suitable for led. The receiver installed in the product has channel 1 selected. Use this channel also on the remote control.

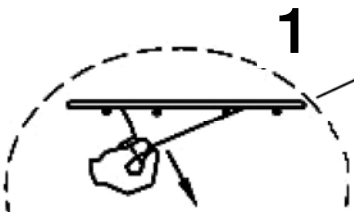

Remove protective film before installing light bulbs

NOTE: Includes the following spare parts:  
 1pcs 1pcs 1pcs 1pcs



16cm 14cm 12cm 10cm

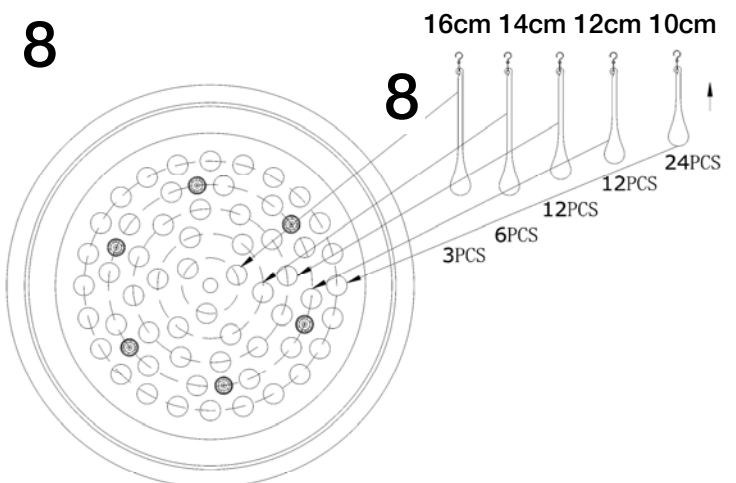

NOTE: For safety reasons, if the electrical wire of this item has any damage, it must be repaired by qualified staff. You may use the following QR code to view the complete technical data sheet of the product:

