

ATENCIÓN: Schuller recomienda que utilice los balancines suministrados en la instalación de esta lámpara.

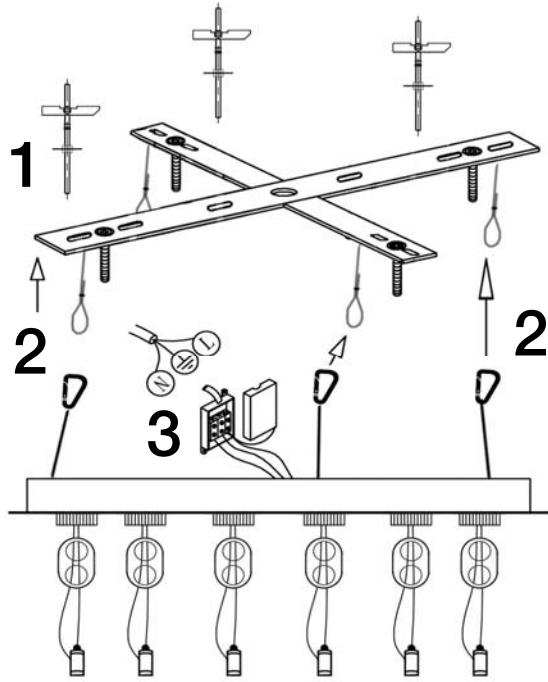

ATENCIÓN
Artículo pesado.
Realizar un anclaje seguro.



NOTA IMPORTANTE
El montaje y la manipulación de este artículo debe hacerse **entre dos personas**.

ATENCIÓN
Este producto incluye leds con dimado de 0-10V y **TRIAC**. Para utilizar con regulador de pared, usar sólo dimmers de estos dos tipos de regulación.

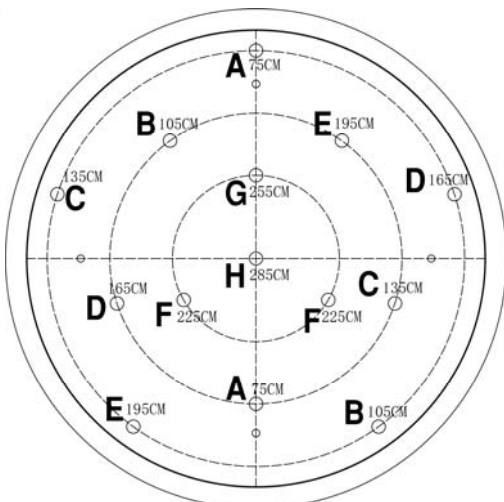
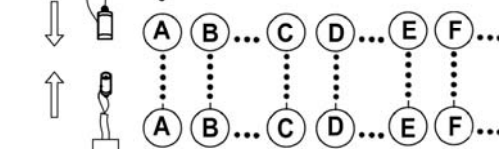
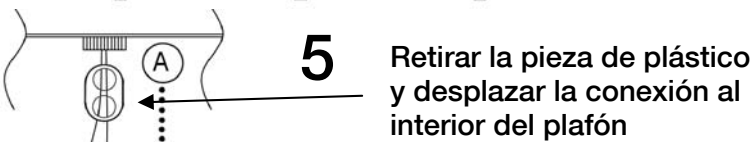
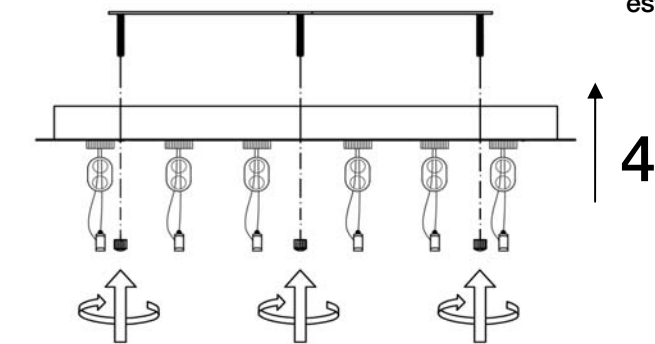
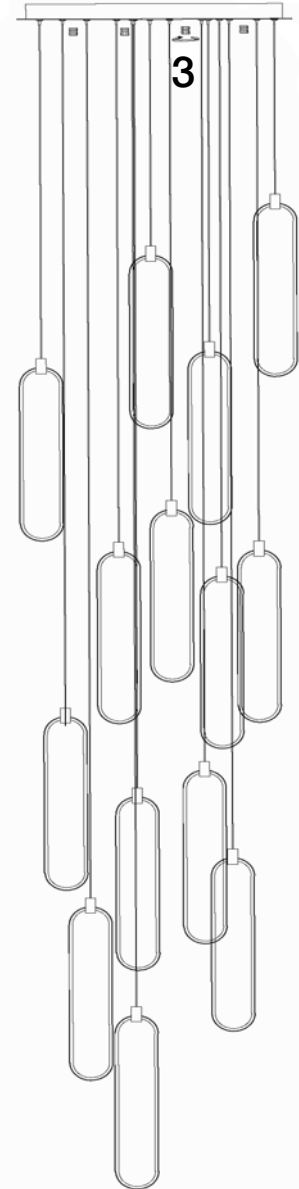

Este producto incluye kit de dimado (Ref. 600811): interruptor inalámbrico y receptor dimable.

Para ver la ficha técnica de producto completa, puede usar el siguiente código QR:



Distintas opciones de instalación.

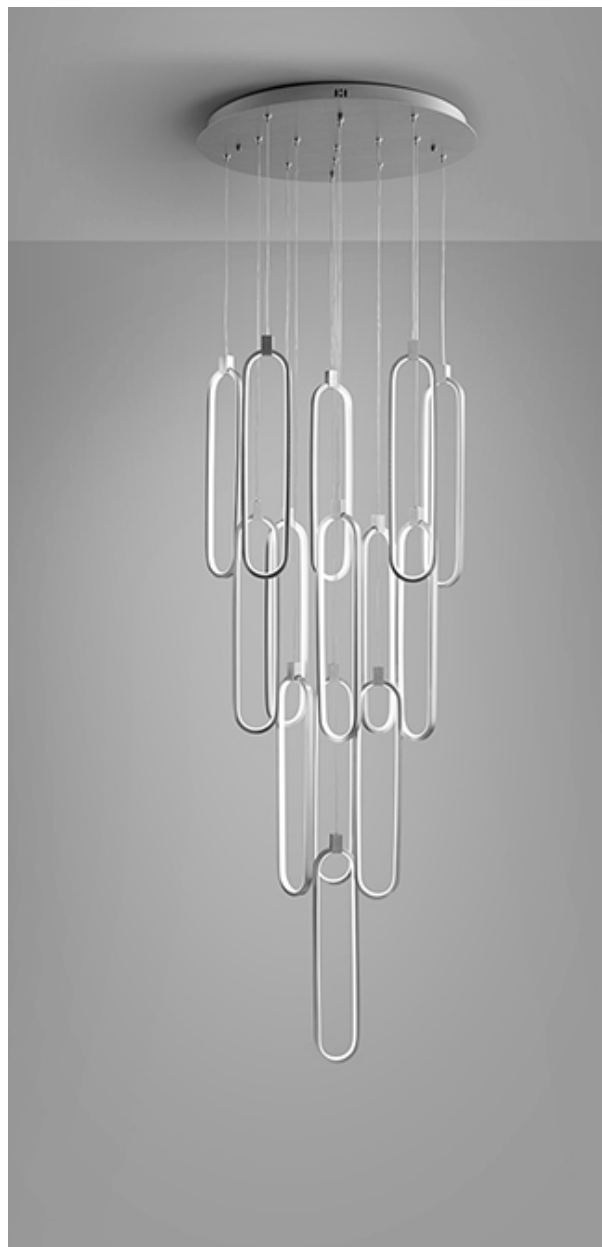
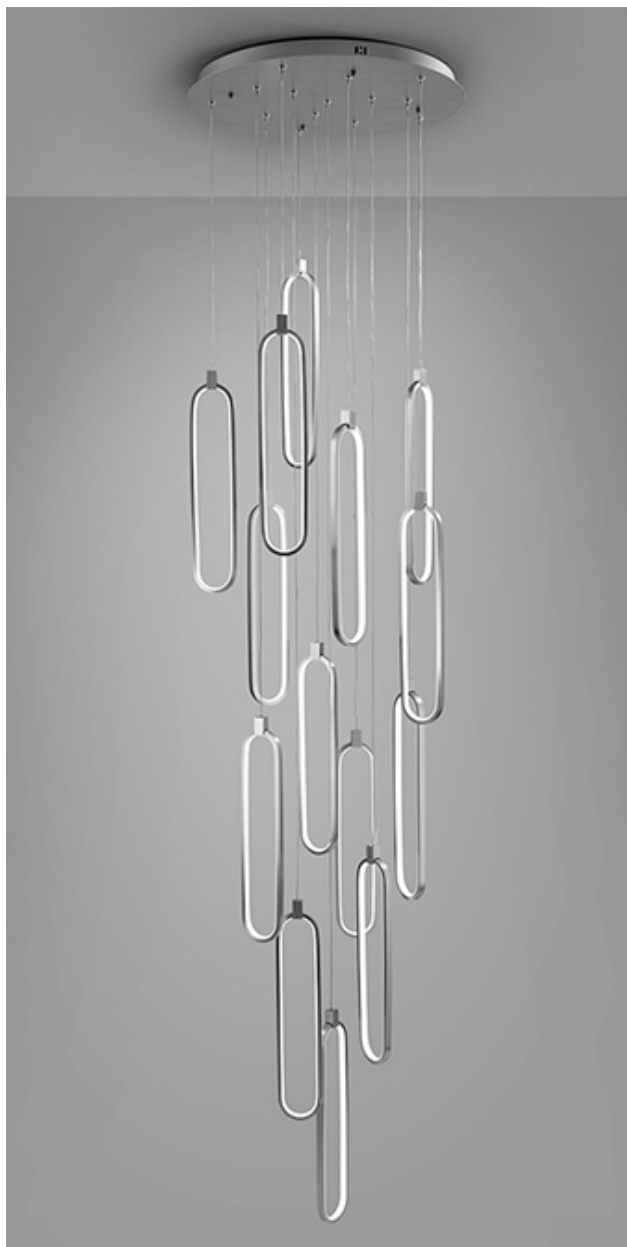

ATTENTION: Schuller recommends to use included special screws when installing this lamp.

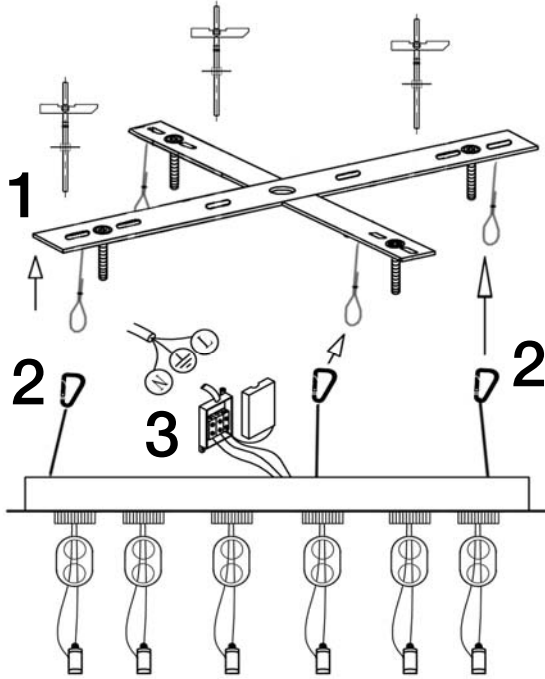

WARNING
Heavy item.
Make sure it is properly fixed



IMPORTANT NOTE
 The assembly of this lamp must be done **by two people**

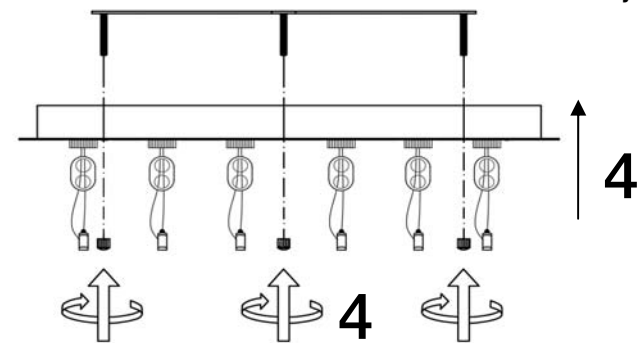

ATTENTION
 This product includes LEDs with 0-10V and **TRIAC** dimming. To use it with wall dimmer, use just this type of dimmers.

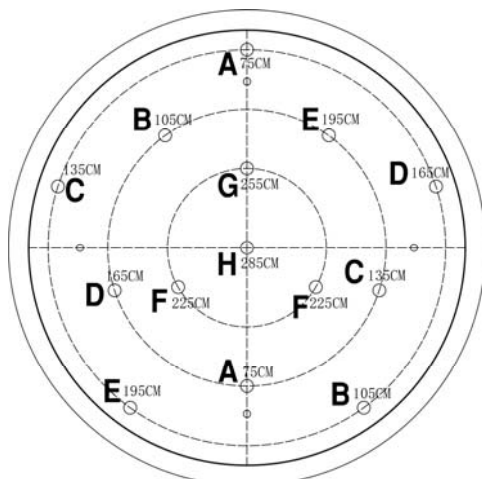
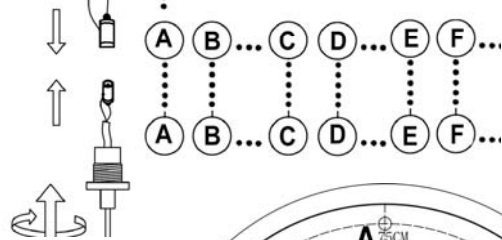
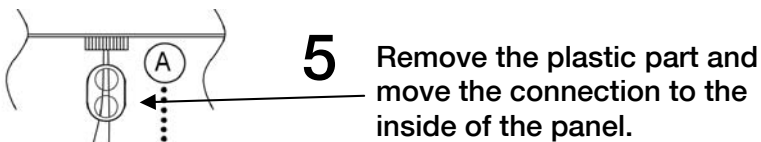
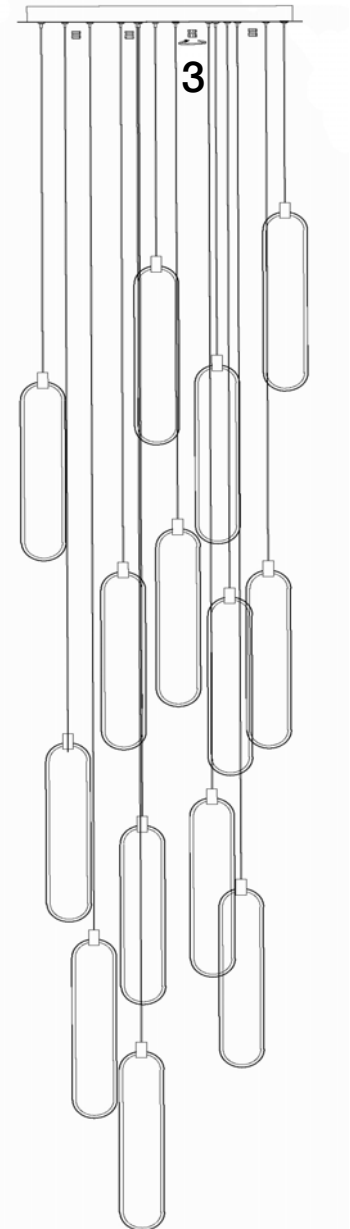

This product includes dimming kit (Ref. 600811): wireless switch and dimmable receiver.

You may use the following QR code to view the complete technical data sheet of the product:



Various installation options.

